

# ROBUS®

COMMERCIAL

## HORIZON

25W, 40W, IP20



### PRODUCT INFORMATION DOCUMENT

#### FEATURES

- Standard and DALI dimmable versions
- Continuous linear lights – both surface mounted and suspended
- CCT3 selectable version is linkable up to 30pcs - max run 42m
- UGR<19 version is linkable up to 45pcs - max run 63m
- With down light as standard and plug and play up-light LED modules available as accessories
- High efficacy up to 136lm/W
- Complete with wall/ceiling mount bracket
- Available accessories: 1.5m AC silflex cable, 1.5m suspension cable

#### CONSTRUCTION

- Die-cast aluminium housing
- Polycarbonate diffuser (RHR40CCT3) or PMMA reflector (RHR2540UGR)
- FR-4 laminate PCB

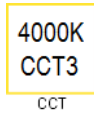
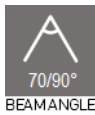
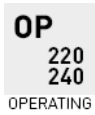
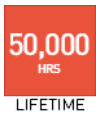

Product Code:	RHR2540UGR-10	RHR2540UGRDD-10	RHR40CCT3-01	RHR40CCT3-10	RHR40CCT3DD-10
Standard					
DALI					
Comparable to:	1x36W T8	1x36W T8	1x36W T8	1x36W T8	1x36W T8
Total Power (W):	26.2	26.5	38.2	38.2	39.4
Power Factor:	0.9	0.97	0.95	0.95	0.97
Total Light Output (lm):	3570	3710	4210	4210	4210
Total Emergency Light Output (lm):	NA	NA	NA	NA	NA
Efficacy (lm/cctW):	136	140	110	110	107
Lux at 1m (lux):	2940	3100	1960	1960	1970
Emergency Lux at 1m (lux):	NA	NA	NA	NA	NA
CCT (K):	4000	4000	3000/4000/5700	3000/4000/5700	3000/4000/5700
CRI:	80	80	80	80	80
IP:	20	20	20	20	20
Operation Temperature (°C):	-20 ≤ Ta ≤ +40	-20 ≤ Ta ≤ +40	-20 ≤ Ta ≤ +40	-20 ≤ Ta ≤ +40	-20 ≤ Ta ≤ +40
Inrush Current:	10.2A/0.6us	4A/182us	7.2A/0.5us	7.2A/0.5us	4A/182us
RG Value:	0	0	0	0	0
SDCM:	<6	<6	<6	<6	<6
P <sub>ST</sub> LM:	NA	NA	NA	NA	NA
SVM:	NA	NA	NA	NA	NA
Energy Class:	C	C	D	D	D
Rated Life to L70B50 (Hrs):	80000	80000	174000	174000	174000
Rated Life to L80B10 (Hrs):	50000	50000	110000	110000	110000
Rated Life to L90B10 (Hrs):	23000	23000	53000	53000	53000
Dimensions LxWxH (mm):	1410x50x73	1410x50x73	1410x50x73	1410x50x73	1410x50x73
Weight (kg):	2.1	2.4	2.1	2.1	2.1
Separate Control Gear Information					
Type of Light Source:	LED	LED	LED	LED	LED
Full Load Efficiency (%):	89	NA	90	90	NA
P <sub>NET</sub> (W):	NA	NA	NA	NA	NA

Product is certified to all the relevant standards.

Please contact our technical department for market specific compliances.

PLEASE NOTE: INFORMATION IN THIS DOCUMENT MAY BE SUBJECT TO CHANGE WITHOUT PRIOR NOTICE

IRE: TEL: +353 1 709 9000  
 UK: TEL: 0800 973 220  
 AUS: TEL: +61 7 3890 5444  
 NZ: TEL: +64 03 668 5285

WEB: ROBUS.COM  
 WEB: ROBUS.COM  
 WEB: ROBUS.COM.AU  
 WEB: ROBUSLED.CO.NZ

LED GROUP EUROPE · UK · AUSTRALIA · NEW ZEALAND · ASIA · MIDDLE EAST · AFRICA

#### Cone Illuminance Diagram

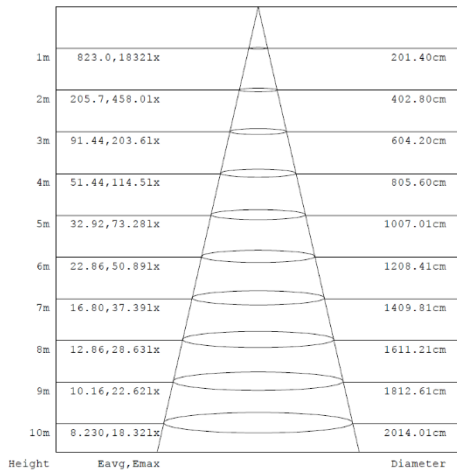
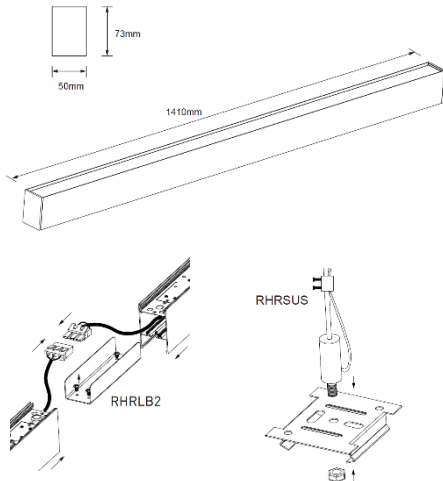

Diagram for RHR40CCT3-10 in 3000K. Other diagrams available on request

#### Dimension Diagram



#### Sensor Data

Time Off Delay:	NA
Illuminance Switching Range:	NA
Sensitivity Range (%):	NA
Mounting Height (max):	NA
Detection Zone Diameter (max):	NA

#### Polar Intensity Diagram

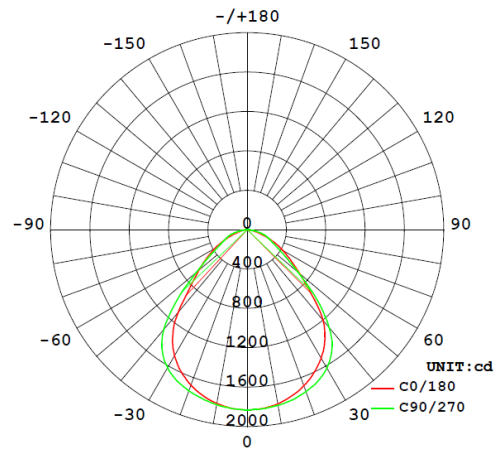

Diagram for RHR40CCT3-10 in 3000K. Other diagrams available on request

#### Accessories

RHR2540-UP	25W 4000K Up Light Module
RHR40CCT3-UP	40W CCT3 Up Light Module
RHRLB2	Linking Bracket With Black And White Cover
RHR SUS	1.5m Suspension Kit
RHR S15	1.5m AC Silflex Cable
RHR SDD15	DALI Silflex 1.5m cable accessory